

Shenandoah **PRO**TM

LOWE'S **PRO**



Style. Value. Quality. ShenandoahPROTM

WHY CHOOSE SHENANDOAH CABINETRY FOR YOUR NEXT PROJECT



Competitive Pro Pricing

- Cabinetry Starting at \$141 per Linear Foot
- No Minimum Order
- Free Jobsite Delivery



Express Manufacturing

- 10-Day Build and Ship*
- Made for When You Need It Fast
- Approximately \$17 per Cabinet
- Only Shenandoah Pro Customers Are Eligible

**Build and ship lead times cited are based on normal supply chain conditions.*



Styles to Satisfy Your Customers

- 3,000+ SKUs
- 14 Door Styles, Including Modern, Transitional, and Timeless
- Full and Partial Overlay
- Raised, Recessed Panel, and Slab Doors
- Available in 27 Stains, Paints and Wrapped Finishes
- 4 Species — Paint, Duraform®, Maple, Cherry
- 300+ Accessory Options



Quality with ADA Accessibility

- Accessible Height (AH) Option available for ADA height flexibility
- Adapable Sink Skirt
- Work Surface Drawer Insert
- Furniture Ends and All Plywood Construction available
- Hardwood Face Frames
- Soft-Closing Doors and Drawers
- 3/4" Full-Depth Base Cabinets

Start to Finish Service
Rapid Response Replacement Program

Lifetime Limited Warranty
shenandoahcabinetry.com/warranty



COMPARE SHENANDOAH PRO, SHENANDOAH PRO EXPRESS & VALUE SERIES PRO



Door Styles	12	2	2
Finishes	27	4	2
Cabinet Construction	Engineered Wood All Plywood	Engineered Wood -	- All Plywood
Drawer Construction	- Dovetailed Hardwood FullAccess Hidden Glides®	Engineered Wood Dovetailed Hardwood Side-Mounted Glides	- Dovetailed Hardwood FullAccess Hidden Glides®
Shelf Thickness	3/4"	1/2"	3/4"
Hinges	6-way-adjustable	6-way-adjustable	6-way-adjustable
Options	All Plywood Construction CushionClose® Furniture Ends Plywood Ends Inverted Frame Increased/Reduced Depth Recessed Toe Kick Matching Interior Void Door Option Cabinet Front Only Void Top Drawer Specialty/Glass Door Accessible Height	- - - Inverted Frame Increased/Reduced Depth Recessed Toe Kick Matching Interior Void Door Option Cabinet Front Only Void Top Drawer Specialty/Glass Door -	All Plywood Construction Standard CushionClose® Standard - - - - - - - - -

Shenandoah **PRO**TM



Stemson Painted Navy with Linen

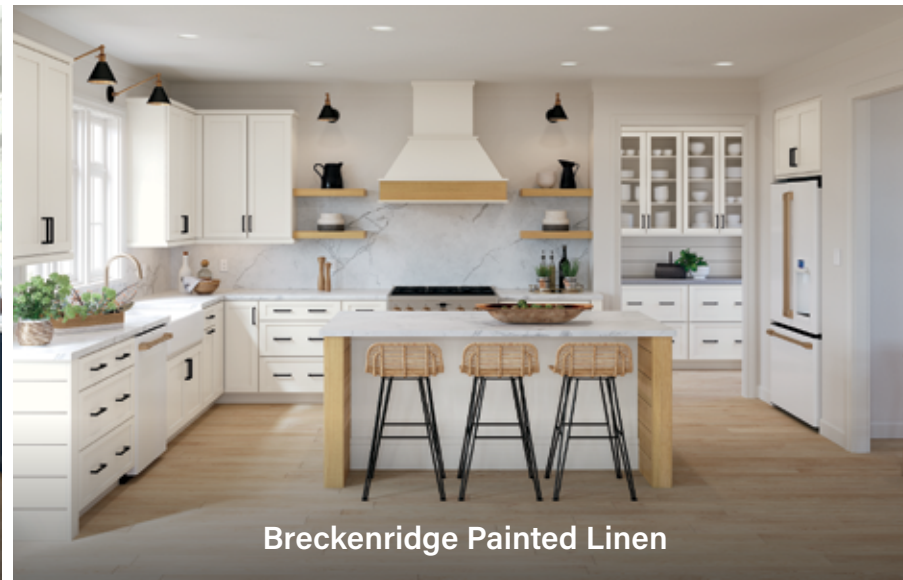

Breckenridge Painted Linen



Warren Painted Boulder

Shenandoah **PRO**TM
COLLECTIONS

DOOR STYLES FOR EVERY PROJECT AT THE RIGHT PRICE*

Shenandoah **PRO**

MODERN

BRECKENRIDGE



Full Overlay
Recessed Panel Doors
Slab Drawer Fronts

Full Overlay
Recessed Panel Doors
5-Piece Drawer Fronts*

Standard Overlay
Recessed Panel Doors
Slab Drawer Fronts

MISSION



Full Overlay
Recessed Panel Doors
Slab Drawer Fronts

Full Overlay
Recessed Panel Doors
5-Piece Drawer Fronts*

SYDNEY



Full Overlay
Slab Doors
Slab Drawer Fronts
Contemporary Style

SOUTHALL



Full Overlay
Recessed Panel Doors
Slab Drawer Fronts
Mitered Corners

Full Overlay
Recessed Panel Doors
5-Piece Drawer Fronts*
Mitered Corners

TRANSITIONAL

WARREN



Full Overlay
Recessed Panel Doors
Mitered Corners
Slab Drawer Fronts

Full Overlay
Recessed Panel Doors
Mitered Corners
5-Piece Drawer Fronts*

IRVINGTON



Full Overlay
Recessed Panel Doors
Mitered Corners
Slab Drawer Fronts

Full Overlay
Recessed Panel Doors
Mitered Corners
5-Piece Drawer Fronts*

CARDIFF



Standard Overlay
Recessed Panel Doors
Slab Drawer Fronts
Mitered Corners

Standard Overlay
Recessed Panel Doors
5-Piece Drawer Fronts*
Mitered Corners

GLASSON



Full Overlay
Recessed Panel Doors
Slab Drawer Fronts

Full Overlay
Recessed Panel Doors
5-Piece Drawer Fronts*

TIMELESS

EDGEWORTH



Full Overlay
Raised Panel Doors
Detailed Slab Drawer Fronts

Full Overlay
Raised Panel Doors
5-Piece Drawer Fronts*

STEMSON



Full Overlay
Raised Panel Doors
Slab Drawer Fronts

Full Overlay
Raised Panel Doors
5-Piece Drawer Fronts

McKINLEY

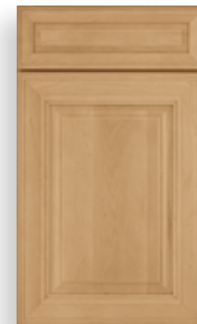

Full Overlay
Raised Panel Doors
5-Piece Drawer Fronts
Mitered Corners

Shenandoah
Value SERIES Pro

FAIRFAX



Standard Overlay
Recessed Veneer Panel
Detailed Slab Drawer Fronts

DEVON

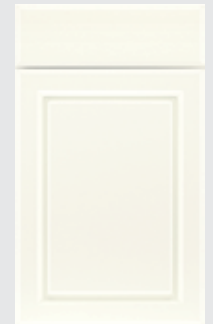

Full Overlay
Thermofoil Raised Panel
Detailed Slab Drawer Fronts

Shenandoah **PRO**
EXPRESS

BRECKENRIDGE

PAINTED LINEN

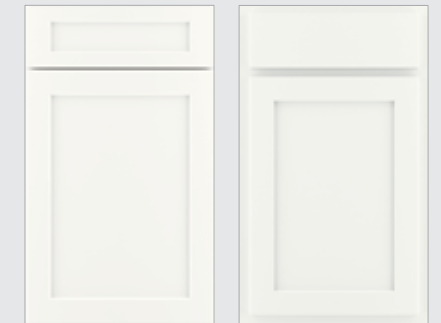

Full Overlay
Recessed Panel Doors
5-Piece Drawer Fronts

Partial Overlay
Recessed Panel Doors
Slab Drawer Fronts

PAINTED STONE



Full Overlay
Recessed Panel Doors
5-Piece Drawer Fronts

*5 piece optional/slab standard 5 piece optional/slab standard.

FINISHES BY COLLECTION

	Painted											Maple						Cherry			Duraform							
	Linen	Peuter Glaze	Vanilla	Biscotti Glaze	Harbor	Ember Glaze	Stone	Boulder	Mist	Navy	Black	Sage	Rye	Cognac	Almond	Latte	Truffe	Slate	Amber	Clove	Slate	Linen	Harbor	Stone	Espresso	Breeze	Drift	
MODERN	Breckenridge (FOL)																											
	Breckenridge (POL)																											
	Mission																											
	Sydney																											
	Southall																											
TRANSITIONAL	Cardiff*																											
	Glasson																											
	Irvington																											
	Warren																											
TIMELESS	Stemson																											
	Edgeworth																											
	McKinley																											

* Glaze

BRECKENRIDGE®



Full & Partial Overlay
 Recessed Panel Doors
 Slab Drawer Fronts
 5-Piece Drawer Fronts*

MAPLE



CHERRY (FULL OVERLAY)



PAINTED



DURAFORM



Painted Linen

*5 piece optional/slab standard 5 piece optional/slab standard.

MISSION®



Full Overlay
 Recessed Solid Panel Doors
 Slab Drawer Fronts
 5-Piece Drawer Fronts*

MAPLE

Rye	Cognac	Truffle	Almond	Latte	Slate

CHERRY

Amber	Clove	Slate

PAINTED

Linen	Vanilla	Harbor	Stone	Boulder	Black
Mist	Navy	Sage			

DURAFORM

Breeze	Drift



Painted Sage with Maple Spice Island

*5 piece optional/slab standard 5 piece optional/slab standard.

SYDNEY®

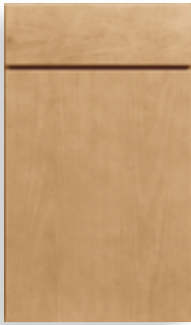

Full Overlay
Slab Doors
Slab Drawer Fronts
Contemporary Style

MAPLE



Rye Cognac Truffle Almond Latte Slate

CHERRY



Amber Clove Slate

PAINTED



Linen Vanilla Harbor Stone Boulder Black



Mist Navy Sage

DURAFORM®

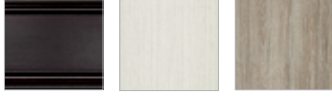

Espresso Breeze Drift



Painted Black, Painted Linen and Maple Rye

WARREN®



Full Overlay
Recessed Panel Doors
Mitered Corners
Slab Drawer Fronts
5-Piece Drawer Fronts*

MAPLE



Rye Cognac Truffle Almond Latte Slate

PAINTED



Linen Pewter** Vanilla Biscotti** Harbor Ember**



Stone Boulder Black Mist Navy Sage



Painted Boulder

*5 piece optional/slab standard 5 piece optional/slab standard.
**Glaze Finish

IRVINGTON®



Full Overlay
 Recessed Panel Doors
 Slab Drawer Fronts
 5-Piece Drawer Fronts*
 Mitered Corners

MAPLE



Rye Cognac Truffle Almond Latte Slate

CHERRY



Amber Clove Slate

PAINTED



Linen Pewter** Vanilla Biscotti** Harbor Ember**



Stone Boulder Black Mist Navy Sage

DURAFORM®



Linen Harbor Stone Espresso



Painted Navy with Duraform Harbor

*5 piece optional/slab standard 5 piece optional/slab standard.
 **Glaze Finish

CARDIFF®



Standard Overlay
Recessed Panel Doors
Slab Drawer Fronts
5-Piece Drawer Fronts*
Mitered Corners

DURAFORM®



Linen Harbor Stone Espresso



Duraform Linen with Stone Island

**5 piece optional/slab standard 5 piece optional/slab standard.*

GLASSON®



Full Overlay
Recessed Panel Doors
Slab Drawer Fronts
5-Piece Drawer Fronts*

MAPLE



PAINTED

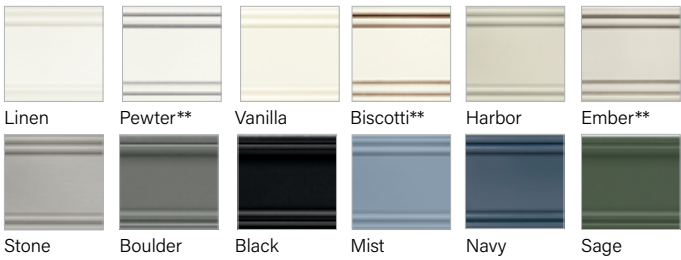

Painted Vanilla and Painted Black

*5 piece optional/slab standard 5 piece optional/slab standard.
**Glaze Finish

SOUTHALL™

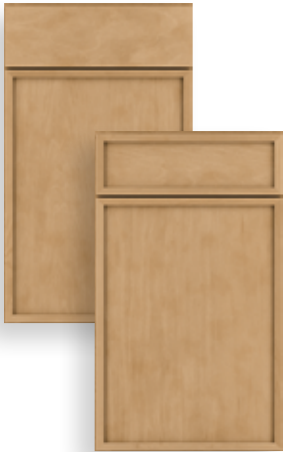

Full Overlay
Recessed Panel Doors
Slab Drawer Fronts
5-Piece Drawer Fronts*
Mitered Corners

MAPLE



CHERRY



PAINTED

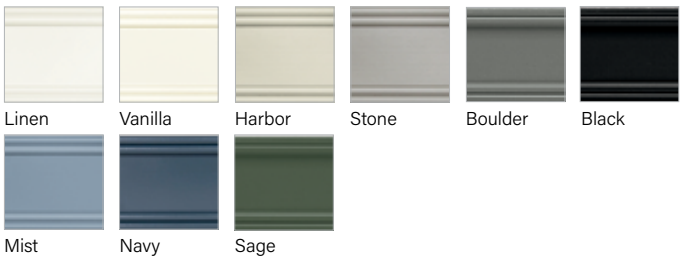

Maple Spice and Painted Boulder

MCKINLEY®

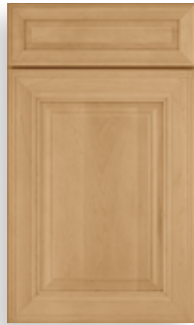

Full Overlay
 Raised Solid Panel Doors
 5-Piece Drawer Fronts*
 Mitered Corners

MAPLE



Rye Cognac Truffle Almond Latte Slate

CHERRY



Amber Clove Slate

PAINTED



Linen Pewter** Vanilla Biscotti** Harbor Ember**



Stone Boulder Black Mist Navy Sage



Painted Vanilla, Painted Mist and Cherry Amber

*5 piece optional/slab standard 5 piece optional/slab standard.
 **Glaze Finish

STEMSON®



Full Overlay
Raised Solid Panel Doors
5-Piece Drawer Fronts*
Mitered Corners

MAPLE



PAINTED



Painted Linen & Painted Navy

*5 piece optional/slab standard 5 piece optional/slab standard.
**Glaze Finish

EDGEWORTH®



Full Overlay
 Raised Solid Panel Doors
 5-Piece Drawer Fronts*
 Square or Cathedral Wall Doors

MAPLE

Rye	Cognac	Truffle	Almond	Latte	Slate

CHERRY

Amber	Clove	Slate

PAINTED

Linen	Pewter**	Vanilla	Biscotti**	Harbor	Ember**
Stone	Boulder	Black	Mist	Navy	Sage

DURAFORM®

Linen



Painted Black

*5 piece optional/slab standard 5 piece optional/slab standard.
 **Glaze Finish

SHENANDOAH PRO
COLLECTIONS

Shenandoah **PRO**TM



Shenandoah **PRO**TM
**FINISHES &
CONSTRUCTION**

A WIDE RANGE OF SPECIES OFFERED IN THE LATEST COLORS AND FINISHES



Maple

Maple is a wonderfully versatile finish, because it works for nearly any style. It can range from white and blonde tones to reddish brown ones. It has a beautiful grain, which will become more prominent when stained. The lighter finishes also tend to become golden with time.

Cherry

With its pin knots, sap pockets, and lovely grain variations, cherry is a classic favorite. Ranging from pale yellow to deep reddish browns with occasional shades of white, green, pink or gray, cherry has a timeless feel, and looks rich and deep when stained. As with most hardwood, cherry darkens gradually over time.

Painted

Painted finishes feel fresh, crisp, and clean. To achieve this finish, we apply paint to a blend of hardwood and engineered materials. This creates a finish for your cabinets that is durable and features a consistent coverage. The paint color may change slightly over time, and you may notice visible joint lines, caused by expansion and contraction over time.

Glazed

A glazed finish adds personality, depth and dimension to the wood. We hand-wipe our glazes onto each door and drawer. That allows the glaze to settle naturally into corners and grooves. This creates the lovely contrast that glazes are known for. A glazed finish feels unique, and part of its charm and appeal is that no two doors will be exactly alike.

Duraform

If you're looking for durability, and a cabinet that is easy to clean and won't warp with moisture, Duraform is a great option. Duraform uses the latest technology to bond a finish to composite wood. Choose from six different colors, from crisp linen to the rich, dark look of the Cascade textured finish. Textured finishes have consistent look and provide exceptional stability.

NO TWO DOORS ARE EXACTLY ALIKE

Whether you choose natural wood or a painted finish, you will find unique results that make your kitchen your own. Since wood expands and contracts, joint lines can appear, which add to the charm of wood cabinetry.

SHENANDOAH HAS THE ON-TREND FINISHES THAT EIGHT OUT OF TEN CUSTOMERS WANT.

Maple finishes



Maple Rye Maple Cognac Maple Truffle



Maple Almond Maple Latte Maple Slate

Cherry finishes



Cherry Amber Cherry Clove Cherry Slate

Painted finishes*



Painted Linen Painted Pewter Glaze Painted Vanilla Painted Biscotti Glaze Painted Harbor Painted Ember Glaze



Painted Stone Painted Boulder Painted Black Painted Mist Painted Navy Painted Sage

Duraform finishes



Duraform Linen Duraform Harbor Duraform Stone Duraform Espresso



Duraform Breeze Duraform Drift

**All glazed and painted finishes carry a premium finish upcharge.*

*5 piece optional/slab standard 5 piece optional/slab standard.
**Glaze Finish

STANDARD CONSTRUCTION OPTIONS BUILT WITH AMERICAN PRIDE AND CRAFTSMANSHIP.

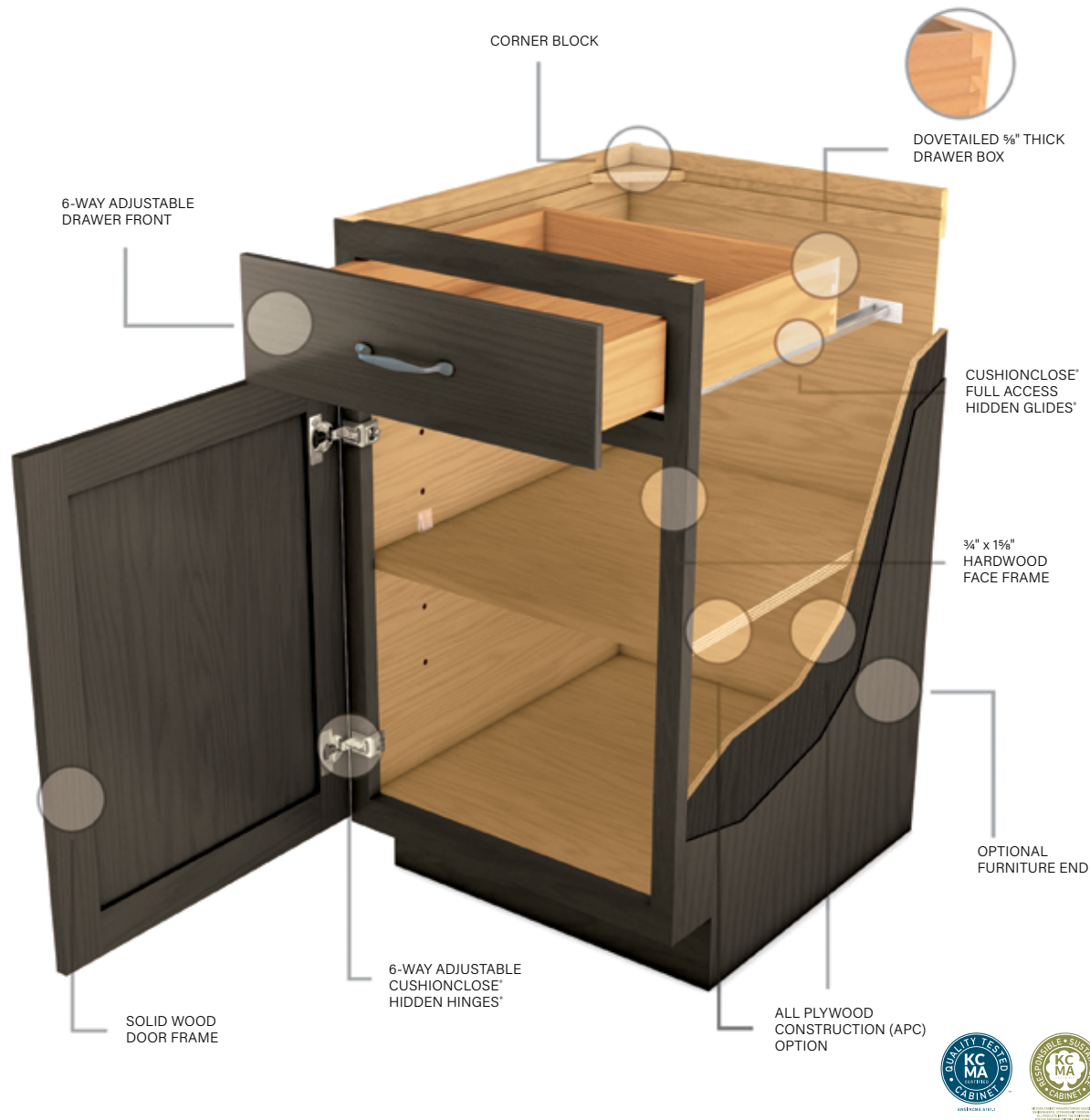

Hardwood Face Frames

We take extra steps in manufacturing because we know how important quality is to you and your customers. Our cabinet face frames are pressure-fitted and mechanically fastened ensuring structural integrity for years to come.



Dovetail Construction

Like high-end furniture, our 5/8" solid wood dovetail drawers meet KCMA industry load standards. The dovetail manufacturing technique ensures a secure, strong and longer lasting box that will hold up to your toughest customer.



Full Access Hidden Glides®

Our glide system has a larger weight-bearing surface that creates a smoother and quieter gliding motion. The drawer box clip has an advanced feature making drawer front adjustments quick and simple.



CushionClose® System

With the Shenandoah CushionClose system, drawers, doors and rollouts close silently and effortlessly. Your customers will appreciate the soft-close mechanism and the whisper-quiet operation in their kitchen or bath.



*5 piece optional/slab standard 5 piece optional/slab standard.
**Glaze Finish

CONSTRUCTION UPGRADES MAKE YOUR PROJECT UNIQUE AND FUNCTIONAL.



All Plywood Construction* Upgrade

Upgraded all-plywood cabinet sides, shelves, cabinet backs, toe kicks and hanging rails are the ultimate in durability and stability and add to the value of your investment.



Furniture Ends Upgrade

Thicker plywood sides on exposed cabinet ends give your cabinets the finished look of fine furniture, make molding installation easier and faster.



Inverted Frame

Available for most standard base cabinets, base cabinets with factory installed wastebasket(s) and base pot and pan organizer cabinets.



Increased Depth and Reduced Depth

Reduced Depth cabinets are available in 1" reductions; minimum cabinet depth is 4". Increased Depth cabinets are available for most

Wall cabinets up to 36" wide.

*1 piece optional slab standard & 3 piece optional slab standard.

**Glaze Finish

*All Plywood Construction refers to the cabinet box components and shelving as detailed in our specification guide ([Lowe's.com/ShenandoahCabinetry/SpecGuide](https://www.lowes.com/ShenandoahCabinetry/SpecGuide)). Plywood components meet the Hardware Plywood & Veneer Association's standards for hardwood and decorative plywood (www.hpva.org).



Matching Interior

This option matches the cabinet's interior to that of the cabinet's exterior sides. Available for wall cabinets, utility cabinets, vanity linen cabinets and refrigerator return panels.



Recessed Toe Kick

Recommended for cabinets at the end of a run, especially in island and peninsula designs.

ACCESSIBLE DESIGN OFFERING



ShenandoahPro gives you the flexibility you need for every job. The Accessible Height (AH) construction option, Adaptable Sink Base Kit and Drawer Work Surface allow you to create accessible spaces no matter the size of your project.

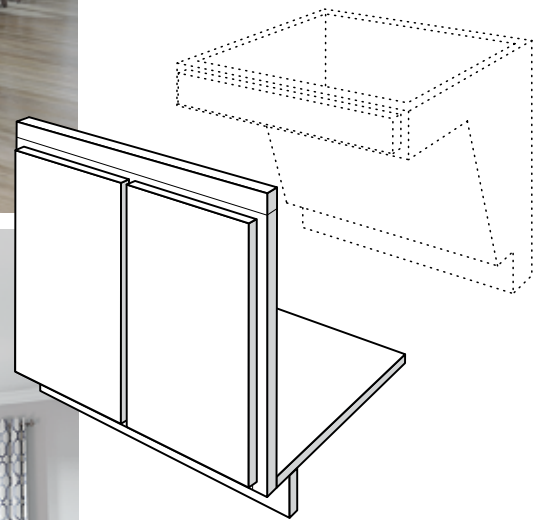

Adaptable Sink Base Kit:

- ASB3034 KIT
- ASB3634 KIT
- ASB3032 KIT
- ASB3632 KIT



Drawer Work Surface

DWS21

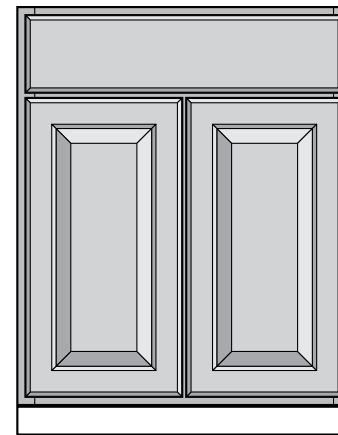
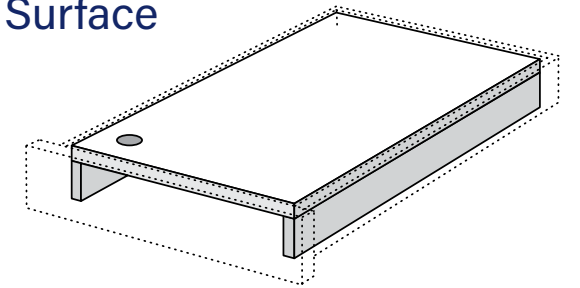

Accessible Height (AH) construction option available for most cabinets with a toe kick

2"

Shenandoah **PRO**TM



Shenandoah **PRO**TM

ACCESSORIES & ORGANIZATION

DECORATIVE ACCENTS AND MOLDING CREATE A CUSTOM LOOK FOR YOUR PROJECT.



Molding stacks, glass inserts and decorator doors take a standalone wall cabinet from ordinary to elegant. Matching interiors add to the beauty of glass doors with complete, seamless color.



A matching range hood adds visual focus, style and functionality to cooking areas.



Add sparkle with custom glass inserts, taking designs to the next level by creating a showpiece in the kitchen.



Corbels, decorator doors and furniture toe kick molding work together to add glamour to an island.



With furniture legs and finished shelving, you can create a furniture style buffet that matches the cabinetry in your kitchen.



Cabinets take on a custom look when you combine stylish hardware with a light rail molding.

WE OFFER FUNCTIONAL STORAGE AND ORGANIZATION SOLUTIONS TO MAKE THE MOST OF YOUR SPACE.



Full Height Base Cabinet with Four Deep Roll Out Trays



Full Height Base Cabinet with Two Deep Roll Out Trays



Base Pot and Pan Organizer



Base Super Susan



Tiered Cutlery Divider

See all the organization options at shenandoahcabinetry.com/accessories.



Peg Drawer Organizer



Spice Rack



Accessory Drawer Divider Insert Kit



Pedestal Drawer



Sink Base Mat



Base Mixer Lift Kit



Wine Storage Cabinet



Base Wastebasket Cabinet



Base Tray Divider Pull Out



Base Pull Out with Utensil Organizer



Base Filler Pull Out



Blind Base Pull Out Kit



Blind Base Swing Out Kit



Knife Block Drawer Insert

GLASS DOORS ARE GREAT FOR ADDING VISUAL INTEREST.



CLEAR GLASS



DERBYSHIRE



MEREDITH



IMPRESSION



RIBBED



FROSTED GLASS



FROSTED ASH



MULLION FRAME



CABINET HARDWARE IS THE FINAL TOUCH THAT BRINGS THE WHOLE KITCHEN TOGETHER.

Knobs & Pulls – Tier 1

Accentuate your style with quality hardware. Grouped in three price tiers, and available in a variety of looks and colors, it's easy to find just the right piece at just the right price.

Classic Knobs and Pulls



Ringed Arch Knobs and Pulls



Toggle Knob



Button Knob



Bow Pull - 6 3/16"

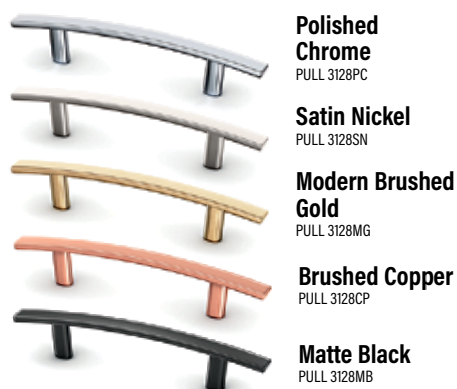

Twisted Crescent Pull



Tab Pull - 1 3/4"



T-Bar Pull - 5 5/16"

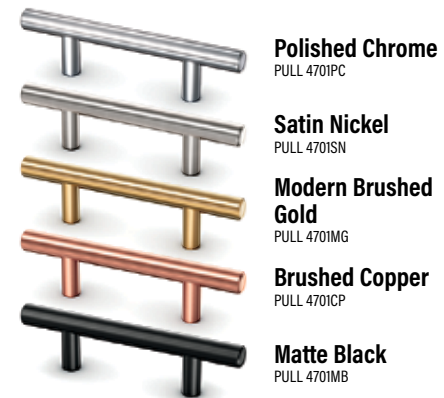

T-Bar Knob



Why buy hardware from Shenandoah?

- Three pricing tiers make it easy to choose within your budget
- Hardware is delivered with the cabinetry, reducing the need for installer callbacks
- The four supplied screw lengths ensure a worry-free installation
- Flat head or low profile screws eliminate damage to the face frame
- Our hardware is covered by our Lifetime Limited Warranty for your customer's peace of mind
- Promotional discounts apply to hardware purchases

See the full hardware selection at
ShenandoahCabinetry.com

CABINET HARDWARE IS THE FINAL TOUCH THAT BRINGS THE WHOLE KITCHEN TOGETHER.

Knobs & Pulls - Tier 2

Rectangular Knobs and Pulls



Tempo Knobs and Pulls

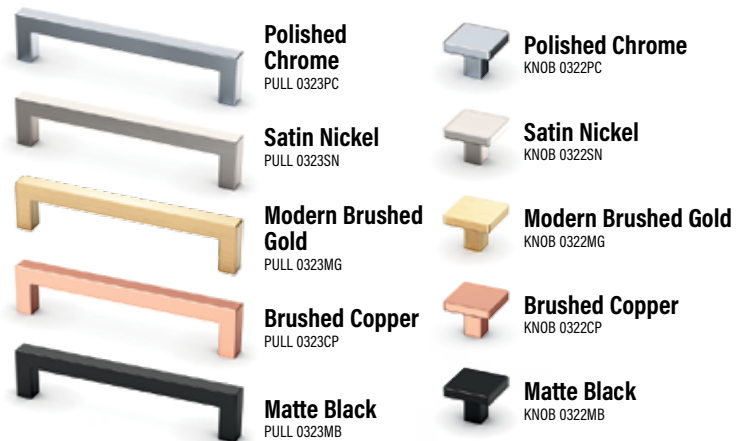

Bow Pull - 7 13/16"

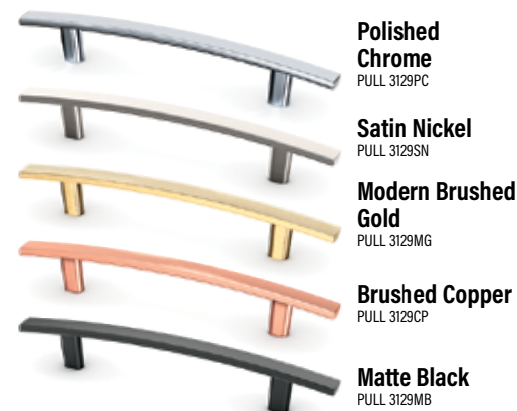

Beaded Pull



T-Bar Pull - 8 5/8"

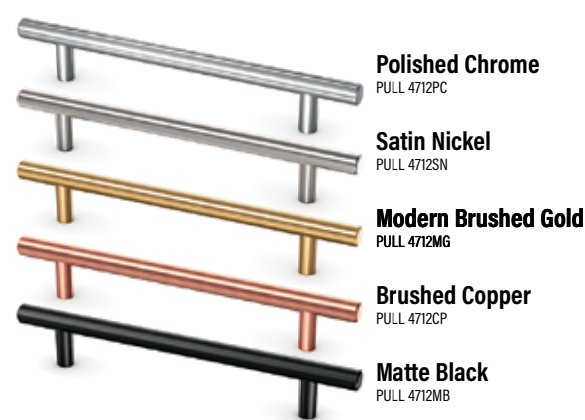

Stamped Knob



Cup Pull



Tab Pull - 3"



Halo Knob

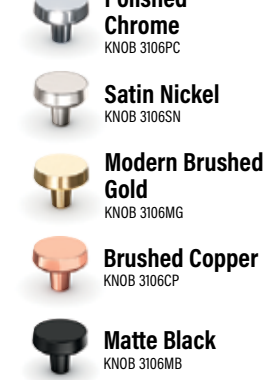

See the full hardware selection at ShenandoahCabinetry.com

CABINET HARDWARE IS THE FINAL TOUCH THAT BRINGS THE WHOLE KITCHEN TOGETHER.

Knobs & Pulls - Tier 3

Antic Knobs and Pulls



Briolette Knobs and Pulls



Radiant Knobs and Pulls



Tab Pull - 6"

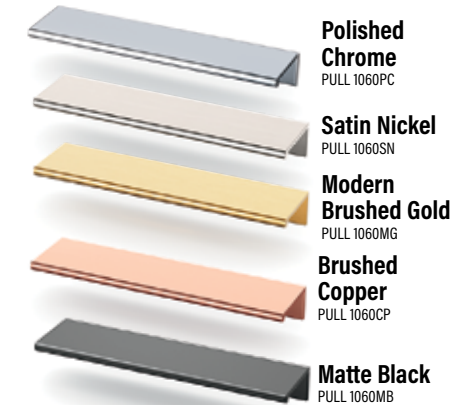

Marquise Pull - 6 7/8"



Marquise Pull - 5 9/16"



T-Bar Pull - 12 7/16"

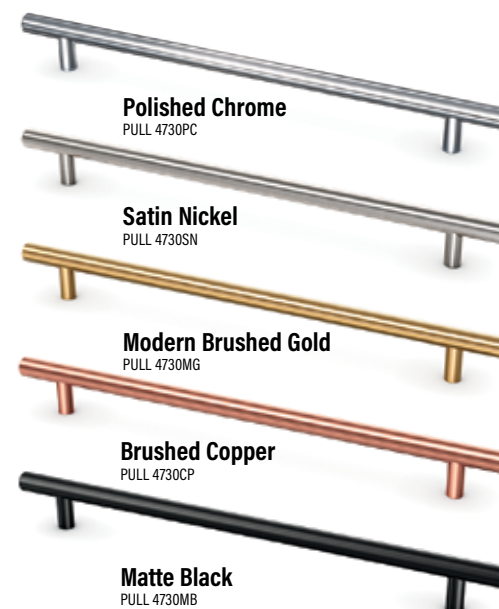

Trillion Knobs and Pulls

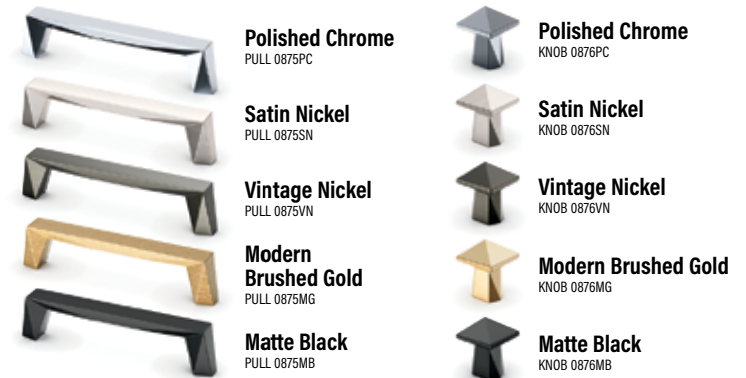

See the full hardware selection at
ShenandoahCabinetry.com

Shenandoah **PRO**TM



Shenandoah *Value* SERIES **Pro**TM

FAIRFAX™



Standard Overlay
Recessed Veneer Panel
Slab Drawer Fronts

MAPLE



Rye

Truffle



Maple Truffle

DEVON[®]



Full Overlay
Thermofoil Raised Panel

THERMOFOIL



White



Thermofoil White

STANDARD CONSTRUCTION



KITCHEN CABINET
MANUFACTURERS ASSOCIATION™

Base Cabinet

Gabinete base

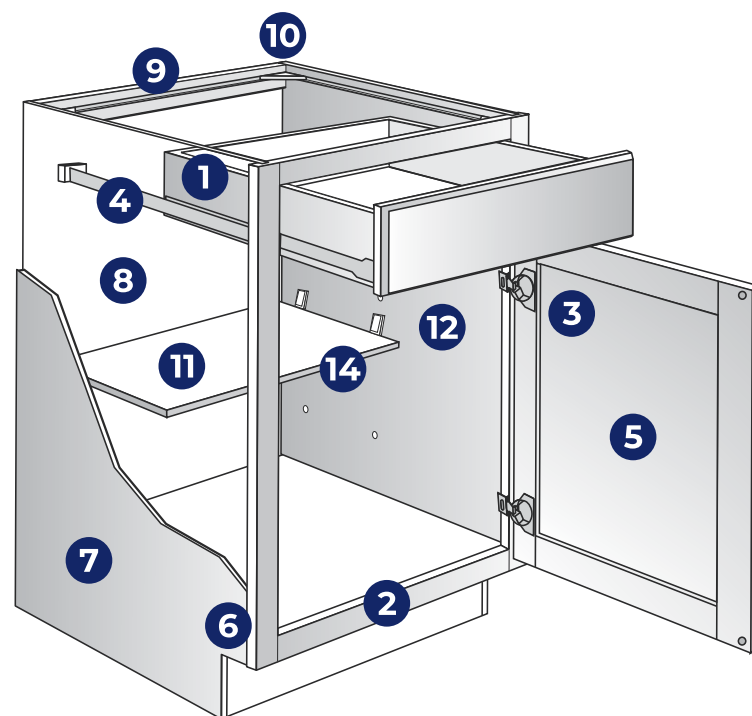

Wall Cabinet

Gabinete de pared

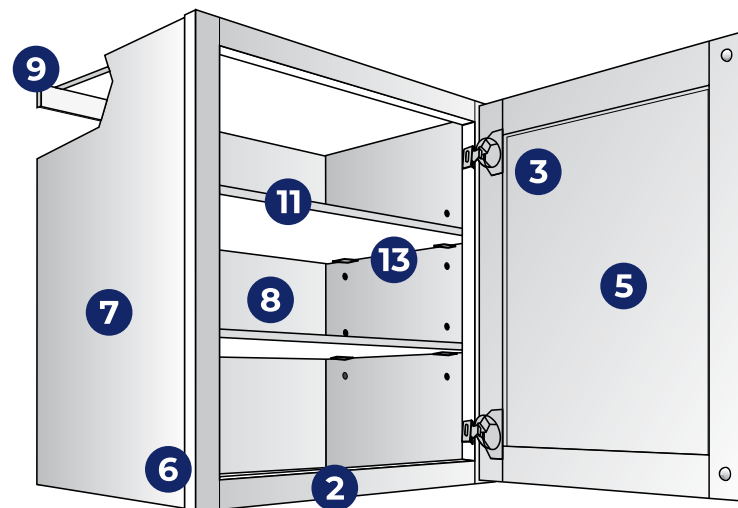

- 1 ½" Thick, 18" Deep Engineered Wood Drawer Box with MDF Drawer Bottom. ⅝" Thick, 18" Deep Solid Wood Dovetail Drawer Upgrade Option.
- 2 ¾" x 1⅝" Hardwood Face Frame
- 3 6-Way-Adjustable Hidden Hinges®
- 4 Side-Mounted Drawer Glides
- 5 Doors, Floating Center Panel
- 6 ¼" Reveal
- 7 ½" Thick Side Return Engineered Wood

- 8 ⅛" Hardboard Substrate Captured Back
- 9 Base Cabinet ¾" Hardwood Hanging Rail. Wall Cabinet ½" Structural Hanging Rail (Top & Bottom).
- 10 Corner Block
- 11 ½" Thick Shelving
- 12 Locking Plastic Shelf Rests
- 13 Metal Shelf Rests

Get extra durability with our solid wood dovetail drawer.

Kitchen drawers see plenty of action day in and day out. Drawer box is 5/8-in thick, 18-in solid wood.



ORGANIZATION



Base Cabinet with Two Sliding Shelves



Base Pot and Pan Organizer



Base Bookshelf Cabinet



Base Pantry Pull Out



Utility Cabinet with Sliding Shelves

Shenandoah **PRO**TM



Shenandoah **PRO**TM *EXPRESS*

